

The JBL logo is displayed in white, bold, sans-serif capital letters within a black rectangular box in the upper left corner. The background of the entire cover is a black and white photograph of a large crowd at a concert, with many people raising their hands in the air, illuminated by stage lights.

JBL

Owner's Manual

**Control Series
Compact Monitors**

Control

thank you for choosing JBL. For over 50 years, JBL has been involved in every aspect of musical and film recording and reproduction, from live performances to monitoring the recordings you will soon play in your home, office, or home theatre.

We're confident that the JBL products you have chosen will provide every note of musical enjoyment you expected – and that when you think about additional loudspeakers for your home and your car, you will once again choose JBL.

Take a moment to complete the enclosed profile card. It enables us to keep you posted on our latest advancements, and helps us to better understand our customers and build products that meet your needs and expectations.

JBL Consumer Products

Read First! Before You Begin.

Included:

CM40, 42, 52, 62

CM40AW, 42AW, 52AW

CM42V & 52V

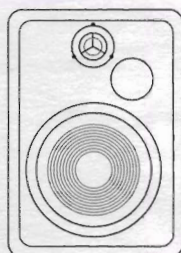
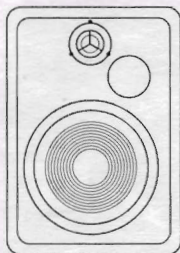
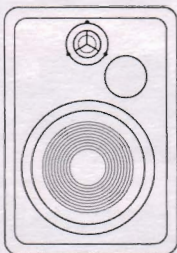

Features:

- Rugged, high-impact molded plastic cabinet
- Built-in wall-mount brackets
- Video-shielded (excludes all-weather models)
- Optional adjustable wall/ceiling-mount brackets available:
 - MTC40, MTC40WHT (white) – for models CM40, 42, 52
CM40AW, 42AW, 52AW
CM42V, 52V
 - MTC60, MTC60WHT (white) – for model CM62.

Note for all-weather models:

While the CM40AW, 42AW, and 52AW are weather-resistant, they are not designed to be immersed in water. Be selective in your outdoor placement. Placing these speakers under roof eaves or a patio awning will offer a slight shelter and help contribute to years of trouble-free performance. When installed outdoors, the speakers should be angled down slightly, using the optional MTC40 mounting brackets.

Speaker Placement

As front speakers

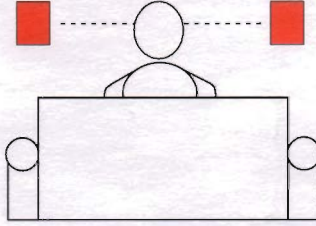
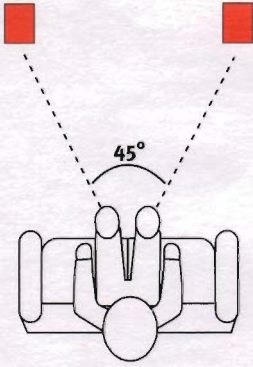

As rear speakers

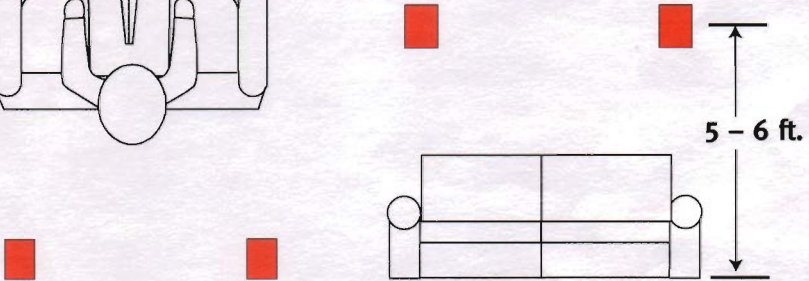
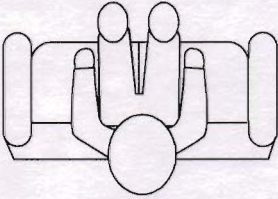

Center speaker

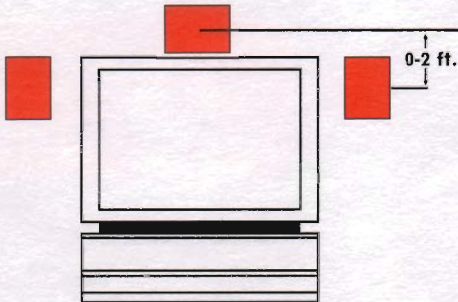

Speaker Connections

Connection Tips

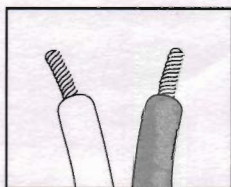

Speakers and electronics terminals have corresponding (+) and (-) terminals. It is important to connect both speakers identically: (+) on the speaker to (+) on the amplifier and (-) on the speaker to (-) on the amplifier. Wiring "out of phase" results in thin sound, weak bass and a poor stereo image.

CM40, 42, 40AW, 42AW

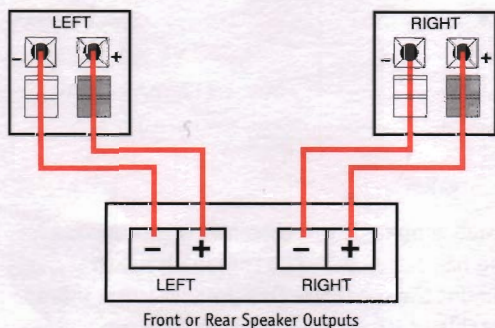

Front or Rear Speaker Outputs

CM42V

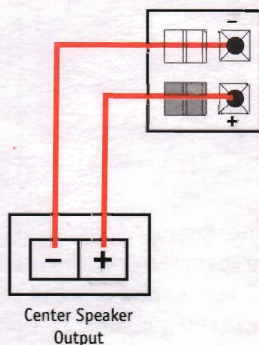

CM52, 62, 52AW

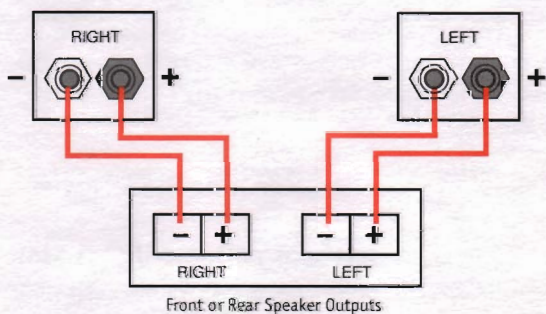

Front or Rear Speaker Outputs

CM52V

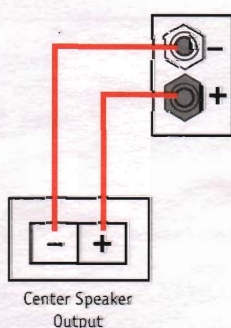

Wall Mounting

CM40, 40AW, 42, 42AW, 42V, 52, 52AW, 52V

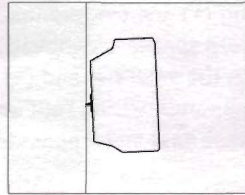
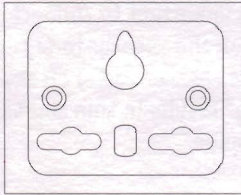

Vertical

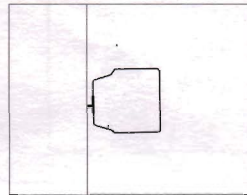

Horizontal

CM62

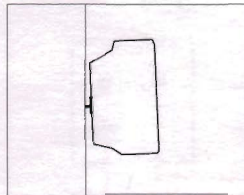
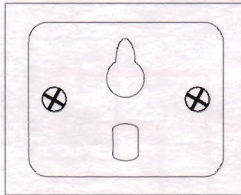

Vertical

The Control Series Speakers may be wall-mounted. The customer is responsible for proper selection and use of mounting hardware, available through hardware stores, to properly and safely wall-mount the speakers. This product is not intended for ceiling mounting. Optional adjustable wall/ceiling-mount brackets are available from JBL. Contact your dealer or call 800-336-4JBL for a dealer near you.

Specifications

	CM40, 40AW	CM42, 42V, 42AW	CM52, 52V, 52AW	CM62
High Frequency Driver	4" Full Range Driver	1/2" Titanium Dome	1/2" Titanium Dome	1/2" Titanium Dome
Low Frequency Driver		4" Poly-Laminate Cone	5-1/4" Poly-Laminate Cone	6-1/2" Poly-Laminate Cone
Crossover Frequency		4kHz	4kHz	3kHz
Frequency Response	70Hz – 16kHz	60Hz – 20kHz	50Hz – 20kHz	45Hz – 20kHz
Sensitivity	87dB	88dB	89dB	89dB
Nominal Impedance	6 Ohms	6 Ohms	6 Ohms	6 Ohms
Recommended Amplifier Power Range	10 – 75 Watts	10 – 80 Watts	10 – 100 Watts	10 – 175 Watts
Dimensions (HxWxD)	10 x 5-3/4 x 4" 225 x 147 x 104mm	10 x 5-3/4 x 4" 225 x 147 x 104mm	10-1/4 x 6-3/4 x 6-1/2" 265 x 171 x 168mm	15-3/8 x 9-1/2 x 9-1/4" 390 x 243 x 262mm
Weight (each)	6 lbs	6 lbs	8 lbs	11 lbs

U.S. Warranty – For warranty information outside the U.S. please contact your local distributor.

JBL 5-Year Limited Warranty
This is an important document.
Attach your bill of sale to this page and keep it in a safe place.
Your bill of sale is your warranty.
The JBL warranty on loudspeakers (except enclosures) remains in effect for **five years** from the date of the first consumer purchase. Enclosures are warranted for **two years** from the date of purchase.

Who is protected by this warranty

The JBL warranty protects the original owner and all subsequent owners providing that the JBL product was purchased from an authorized dealer in the United States or purchased by military personnel from an authorized military outlet. A copy of the original dated bill of sale must be presented whenever warranty service is required.

What is covered by this warranty

Except as specified below, the JBL warranty covers all defects in material and workmanship. The following are **not** covered: Damage caused by accident, misuse, abuse, product modification or neglect;

damage occurring during shipment; damage from failure to follow instructions contained in the instruction manual; damage resulting from the performance of repairs by someone not authorized by JBL; damage caused by installation of parts that do not conform to JBL specifications; units used for other than home use; any claims based on misrepresentations by the seller; products sold on an "as-is" or final sale basis; or the cost of installing, removing, or reinstalling the unit. JBL's liability is limited to the repair or replacement, at our option, of any defective product and shall not include incidental or consequential damages. JBL reserves the right to replace a discontinued model with a comparable model. Any replacement units or parts may be new or rebuilt.

To obtain warranty service

If you require warranty service, please return the product to your dealer. If this is not possible and you live in the United States, please call 1-800-336-4JBL, for information on how to obtain service or replacement. If purchased outside the United

States, contact your local dealer for repair or replacement.

Do not return products to the JBL factory without authorization. They will be returned unopened.

You are responsible for transporting your product for repair or replacement. JBL will pay reasonable return charges for delivery to any location in the United States if the repair or replacement is covered under the warranty. Correspondence with JBL should be addressed to: JBL Customer Service, 80 Crossways Park West, Woodbury, NY 11797 or fax us at 516-496-0812. Outside the United States, please contact your local distributor.

This warranty gives you specific legal rights. You may also have other rights which vary from state to state. Some states do not allow the exclusion or limitation of incidental or consequential damages or limitations on how long an implied warranty lasts, so the above may not apply to you.

Notice to Purchaser: JBL assumes no responsibility or liability for injuries or property damage — direct, indirect, or consequential — resulting from the improper installation of Control loudspeakers.



JBL Consumer Products
80 Crossways Park West, Woodbury, NY 11797
8500 Balboa Boulevard, Northridge, CA 91329
1-800-336-4JBL (4525) (USA only)

© 1996 JBL, Incorporated.

JBL is a registered trademark of JBL, Incorporated.

Printed in USA 4/96  Part No. CONSEROM

H A Harman International Company

Declaration of Conformity



We, JBL Europe A/S
Kongensvej 194B
DK-3450 Birkerød
DENMARK

declare in own responsibility, that the loudspeakers described in this owner's manual are in compliance

with technical standards:

EN 50 081-1/1992

EN 50 082-1/3:1995

Steen Michaelsen
JBL Europe A/S
Birkerød, DENMARK 4/96